

NEW

CA MD E RF RANGE

Centrifugal duct fans for roof mounting

Suitable for outdoor roof installation at the end of ventilation ducts in residential and industrial environments for the channelling of clean air: factories, hospitals, gyms, restaurants, etc...



LONG LIFE 30.000 h

- **8 models: CA 100 MD E RF, CA 125 MD E RF, CA 150 Q MD E RF, CA 150 MD E RF, CA 160 MD E RF, CA 200 MD E RF, CA 250 MD E RF, CA 315 MD E RF.**
- Stripped and phosphated steel structure, bands and bases, painted with polyester powder which is resistant to atmospheric agents.
- Induction motor with built-in rotor, manual reset thermal protection device for diameters 100, 125 and 150 Q.
- Induction motor with external rotor, manual reset thermal protection device for diameters 150, 160, 200, 250 and 315.
- 2 speed motors (offer 2 levels of airflow, pressure, noise emissions and consumption).
- Low specific consumption levels.
- Low noise levels.
- Motor supports with built-in airflow direction flaps in resin plastic material with high structural strength.
- Wiring box in plastic material with high structural strength.
- Anti-UV thermoplastic resin cover in grey.
- Anti-UV thermoplastic resin support in grey for diameters 100, 125, 150 and 160.
- Wide range of continuous operation temperatures between -25°C and +55 °C.
- Protection rating: IP44 for model 150, 160, 200, 250, 315 CA MD E RF.
- Protection rating: IP45 for model 100, 125 and 150 Q CA MD E RF.
- Insulation class: II. □

TECHNICAL DATA

Models	Code	W min/max	A min/max	RPM min/max	Max Airflow		Max Prssure		Lp dB(A)* min/max	Max °C
					m³/h min/max	l/s min/max	mmH₂O min/max	Pa min/max		
CA 100 MD E RF	16140	38 - 85	0.28 - 0.40	1590 - 2430	180 - 280	50 - 78	32 - 41	314 - 402	27.3 - 37.5	50
CA 125 MD E RF	16141	38 - 85	0.28 - 0.40	1345 - 2400	220 - 380	61 - 106	26 - 38	255 - 373	21.1 - 40.2	50
CA 150 Q MD E RF	16142	38 - 85	0.28 - 0.40	1490 - 2370	250 - 400	69 - 111	21 - 32	206 - 314	23.8 - 37.5	50
CA 150 MD E RF	16183	35 - 88	0.34 - 0.39	1290 - 2650	235 - 480	65 - 133	33 - 44	324 - 431	24.6 - 43.8	55
CA 160 MD E RF	16184	40 - 88	0.36 - 0.39	1500 - 2640	310 - 530	86 - 147	34 - 43	333 - 422	30.4 - 44.8	55
CA 200 MD E RF	16185	40 - 95	0.36 - 0.41	1300 - 2560	360 - 710	97 - 197	41 - 46	402 - 451	23 - 31.7	55
CA 250 MD E RF	16186	60 - 115	0.51 - 0.53	1490 - 2630	410 - 760	114 - 211	38 - 50	490 - 539	28.6 - 43.8	55
CA 315 MD E RF	16187	58 - 130	0.51 - 0.57	1450 - 2630	450 - 900	125 - 250	50 - 58	490 - 569	32.8 - 40.7	55

* Sound pressure level measured at 3 m in free field conditions with long-cased appliance in delivery mode in accordance with standard EN ISO 9614.

Electric supply: 230 V ~ 50 Hz.





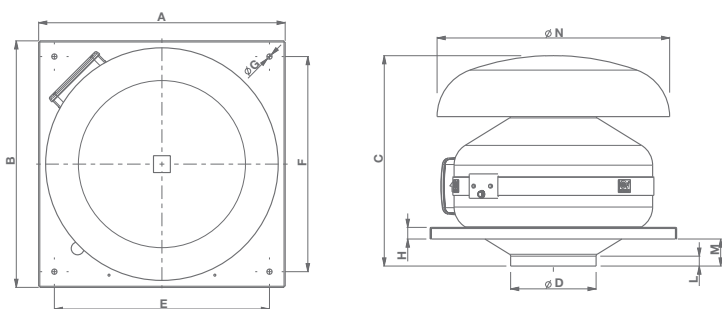



DIMENSIONS



Models	A	B	C	Ø D	E	F	Ø G	H	L	M	Ø N	Kg
CA 100 MD E RF				97					15			3.5
CA 125 MD E RF	334	334	305	122	280	280			23	35	300	3.5
CA 150 Q MD E RF				147					30			3.5
CA 150 MD E RF				147			9	20	17	47		5.8
CA 160 MD E RF	424	424	365	157	370	370			18		400	5.9
CA 200 MD E RF				197					20			6.1
CA 250 MD E RF				375	247				38	49		7.9
CA 315 MD E RF	489	489	415	312	435	435			36	65	534	14

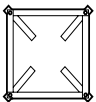

Dimensions (mm)

PRODUCT ACCESSORIES

Models	Code	Product									
		CA 100 MD E RF code 16140	CA 125 MD E RF code 16141	CA 150 Q MD E RF code 16142	CA 150 MD E RF code 16183	CA 160 MD E RF code 16184	CA 200 MD E RF code 16185	CA 250 MD E RF code 16186	CA 315 MD E RF code 16187		
	C 1.5 Electronic speed controller 1.5 A	12966	●	●	●	●	●	●	●	●	
	SCB Built-in controller adaptor for C 1.5	22481	12966								
	C HCS Environmental sensor for humidity	12994	●	●	●	●	●	●	●	●	
	C TEMP Environmental sensor for temperature	12992	●	●	●	●	●	●	●	●	
	C SMOKE Environmental sensor for air quality	12993	●	●	●	●	●	●	●	●	
	C PIR Passive infrared sensor	12998	●	●	●	●	●	●	●	●	
	C TIMER Adjustable over-run timer	12999	●	●	●	●	●	●	●	●	
	CARF-C 125 Sub-frame	22543	●	●	●						
	CARF-C 150-160-200 Sub-frame	22544				●	●	●			
	CARF-C 250-315 Sub-frame	22545							●	●	

Description and sizes on page 98

SYSTEM COMPONENTS

Models	Code	Product							
		CA 100 MD E RF code 16140	CA 125 MD E RF code 16141	CA 150 Q MD E RF code 16142	CA 150 MD E RF code 16183	CA 160 MD E RF code 16184	CA 200 MD E RF code 16185	CA 250 MD E RF code 16186	CA 250 MD E RF code 16187
	IN-LINE-S 100 Backdraught shutter nominal diameter 100 mm	22551	●						
	IN-LINE-S 125 Backdraught shutter nominal diameter 125 mm	22556		●					
	IN-LINE-S 150 Backdraught shutter nominal diameter 150 mm	22562			●	●			
	IN-LINE-S 160 Backdraught shutter nominal diameter 160 mm	22563					●		
	IN-LINE-S 200 Backdraught shutter nominal diameter 200 mm	22566						●	
	IN-LINE-S 250 Backdraught shutter nominal diameter 250 mm	22571							●
	IN-LINE-S 315 Backdraught shutter nominal diameter 315 mm	22576							●
	CA-G 100 Intake protection grille nominal diameter 100 mm	22750	●						
	CA-G 125 Intake protection grille nominal diameter 125 mm	22755		●					
	CA-G 150 Intake protection grille nominal diameter 150 mm	22760			●	●			
	CA-G 160 Intake protection grille nominal diameter 160 mm	22762					●		
	CA-G 200 Intake protection grille nominal diameter 200 mm	22765						●	
	CA-G 250 Intake protection grille nominal diameter 250 mm	22770							●
	CA-G 315 Intake protection grille nominal diameter 315 mm	22771							●
	CA-FU 100 Pipe clamps (2 pieces) nominal diameter 100 mm	22667	●						
	CA-FU 125 Pipe clamps (2 pieces) nominal diameter 125 mm	22668		●					
	CA-FU 150 Pipe clamps (2 pieces) nominal diameter 150 mm	22669			●	●			
	CA-FU 160 Pipe clamps (2 pieces) nominal diameter 160 mm	22666					●		
	CA-FU 200 Pipe clamps (2 pieces) nominal diameter 200 mm	22671						●	
	CA-FU 250 Pipe clamps (2 pieces) nominal diameter 250 mm	22672							●
	CA-FU 315 Pipe clamps (2 pieces) nominal diameter 315 mm	22673							●

Description and sizes on page 98

PERFORMANCE CURVES

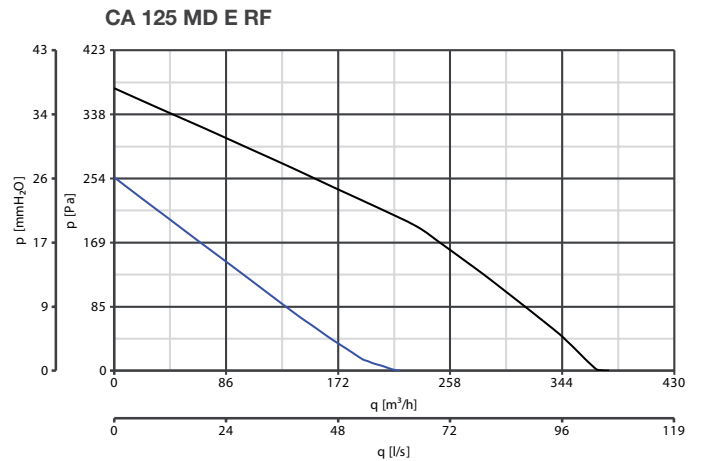
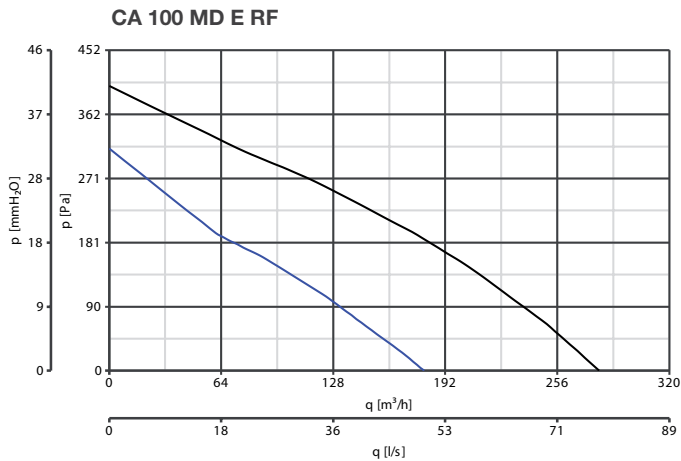

CA 150 Q MD E RF

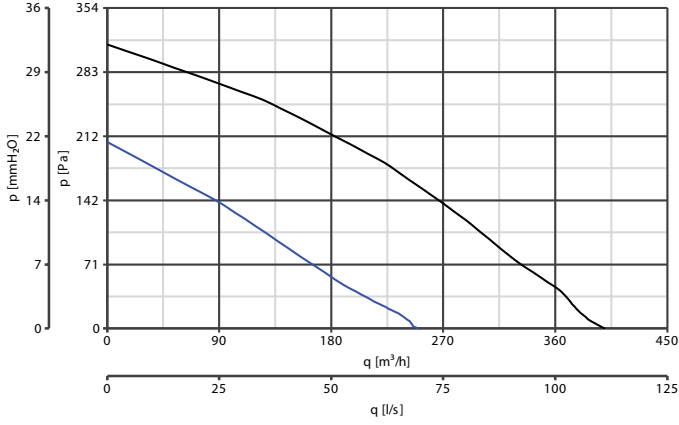

CA 150 MD E RF

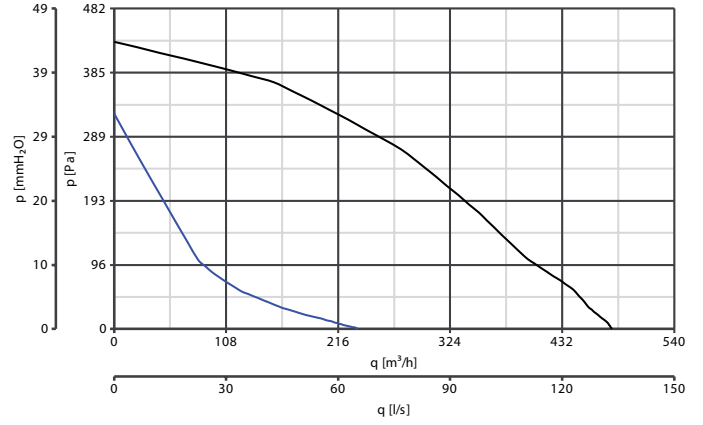

CA 160 MD E RF

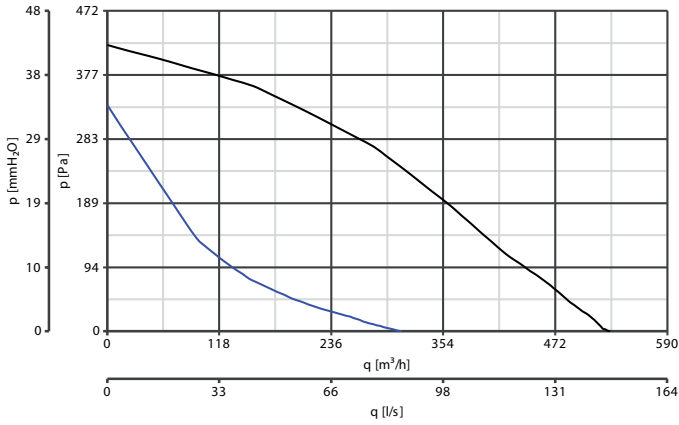

CA 200 MD E RF

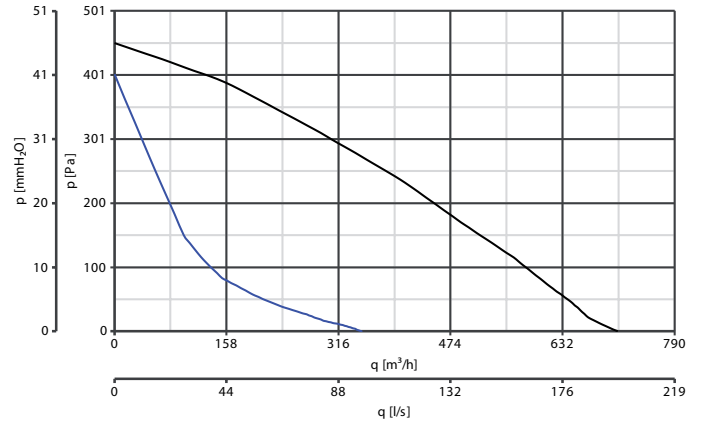

CA 250 MD E RF

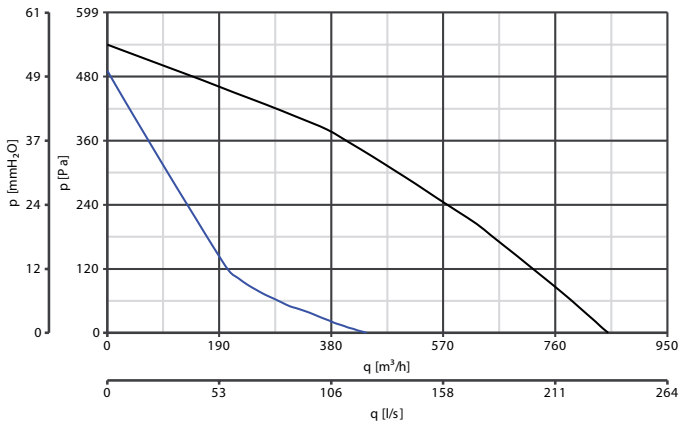

CA 315 MD E RF

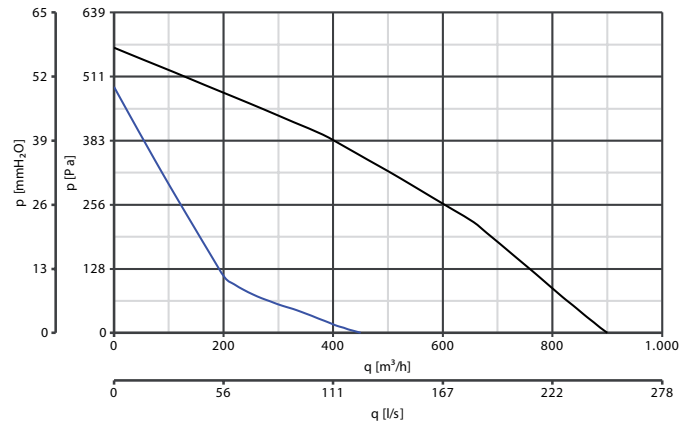

— min. — max.

